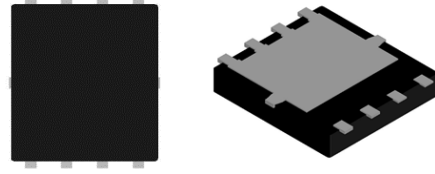

FEATURES

- Drain-Source Withstand Voltage: 60V
- Max. $R_{DS(on)}$: $25m\Omega @ V_{GS}=10V$
 $44m\Omega @ V_{GS}=4.5V$
- Automotive applications
- AEC-Q101 Qualified
- Excellent ON resistance
- General footprint package PDFN5×6-8L
- 100% Rg and Avalanche tested
- MSL1

PRODUCT APPEARANCE

PDFN5×6-8L

DESCRIPTION

The SNM0625DNAQ is N-Channel enhancement MOS Field Effect Transistor. Uses advanced trench technology and design to provide excellent $R_{DS(ON)}$ with low gate charge. This device is suitable for use in high performance automotive DC-DC conversion, power switch and charging circuit. Standard Product SNM0625DNAQ is in compliance with RoHS.

Applications:

- Automotive systems
- DC/DC converters
- Power supply converters circuit
- Load/Power Switching for portable device

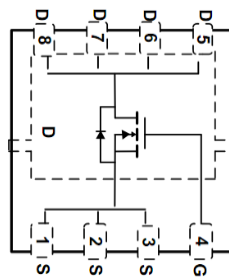
PIN CONFIGURATION

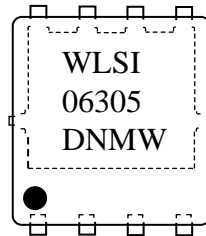
MARKING

WLSI = Company (Group) Code

06305 = Device Code

DN = Special Code

M = Month

W = Week

LIMITING VALUES

Parameter	Symbol	Condition	Value	Unit
Drain-Source Voltage	V_{DS}		60	V
Gate-Source Voltage	V_{GS}		± 20	V
Continuous Drain Current	I_D	$T_C=25^\circ\text{C}$	27	A
		$T_C=100^\circ\text{C}$	19	A
Pulsed Drain Current ⁽³⁾	I_{DM}		62	A
Continuous Drain Current	I_D	$T_A=25^\circ\text{C}$	8	A
		$T_A=100^\circ\text{C}$	5	A
Avalanche Energy $L=0.3\text{mH}$	E_{AS}		14	mJ
Power Dissipation ⁽²⁾	P_D	$T_C=25^\circ\text{C}$	38	W
		$T_C=100^\circ\text{C}$	19	W
Power Dissipation ⁽¹⁾	P_D	$T_A=25^\circ\text{C}$	3.0	W
		$T_A=25^\circ\text{C}$	1.5	W
Operating Junction Temperature	T_J		-55 to 175	$^\circ\text{C}$
Storage Temperature Range	T_{STG}		-55 to 175	$^\circ\text{C}$

THERMAL RESISTANCE RATINGS

Single Operation					
Parameter		Symbol	Typical	Maximum	Unit
Junction-to-Ambient Thermal Resistance ⁽¹⁾	Steady State	R _{θJA}	42	50	°C/W
Junction-to-Case Thermal Resistance ⁽²⁾	Steady State	R _{θJC}	3.8	3.9	

ELECTRONICS CHARACTERISTICS

Parameter	Symbol	Conditions	Min	Typ	Max	Unit
OFF CHARACTERISTICS						
Drain-to-Source Breakdown Voltage	BV _{DSS}	V _{GS} =0 V, I _D = 250μA	60			V
Drain-to-Source Breakdown Voltage Temperature Coefficient	BV _{DSS} /T _J			22		mV/°C
Zero Gate Voltage Drain Current	I _{DSS}	V _{DS} =60V, V _{GS} = 0V, T _J =25°C			10	μA
		V _{DS} =60V, V _{GS} = 0V, T _J =125°C			250	μA
Gate-to-source Leakage Current	I _{GSS}	V _{DS} =0 V, V _{GS} = 20V			100	nA
ON CHARACTERISTICS						
Gate Threshold Voltage	V _{GS(TH)}	V _{GS} =V _{DS} , I _D = 250μA	1.3	1.7	2.1	V
Threshold Temperature Coefficient	V _{GS(TH)} /T _J			-4.4		mV/°C
Drain-to-source On-resistance ⁽⁴⁾	R _{DS(on)}	V _{GS} =10V, I _D =10A		19	25	mΩ
		V _{GS} =4.5V, I _D =10A		32	44	
CHARGES, CAPACITANCES AND GATE RESISTANCE						
Input Capacitance	C _{ISS}	V _{GS} = 0V, f = 1.0MHz, V _{DS} =25 V		400		pF
Output Capacitance	C _{OSS}			210		
Reverse Transfer Capacitance	C _{RSS}			24		
Total Gate Charge ⁽⁵⁾	Q _{G(TOT)}	V _{GS} =10V, V _{DS} = 48V, I _D =10A		9.6		nC

Parameter	Symbol	Conditions	Min	Typ	Max	Unit
Total Gate Charge ⁽⁵⁾	$Q_{G(TOT)}$	$V_{GS}=4.5V,$ $V_{DS}=48V,$ $I_D=10A$		5.2		
Gate-to-Source Charge ⁽⁵⁾	Q_{GS}			1.8		
Gate-to-Drain Charge ⁽⁵⁾	Q_{GD}			2.5		
Gate Resistance	R_g	$f = 1MHz$		1.2		Ω
SWITCHING CHARACTERISTICS ⁽⁵⁾						
Turn-On Delay Time	$t_d(ON)$	$V_{GS}=4.5V,$ $V_{DS}=48V,$ $I_D=10A, R_G=1.0\Omega$		6.0		ns
Rise Time	t_r			16.0		
Turn-Off Delay Time	$t_d(OFF)$			9.6		
Fall Time	t_f			6.4		
Body Diode Reverse Recovery Time	t_{rr}	$I_F=10A,$ $dI/dt=100A/\mu s$		15		ns
Body Diode Reverse Recovery Charge	Q_{rr}	$I_F=10A,$ $dI/dt=100A/\mu s$		6.3		nC
BODY DIODE CHARACTERISTICS						
Forward Voltage ⁽⁴⁾	V_{SD}	$V_{GS}=0V, I_S=10A$	0.5	0.85	1.2	V

($T_J=25^\circ C$, unless otherwise noted.)

Note:

- (1) FR-4 board (38mm×38mm×t1.6mm, 70μm Copper) partially covered with copper (645mm² area). The power dissipation P_{DSM} is based on Junction-to-Ambient thermal resistance value and the $T_{J(MAX)}=175^\circ C$. The value is only for reference, any application depends on the user's specific board design.
- (2) The power dissipation P_D is based on $T_{J(MAX)}=175^\circ C$, using junction-to-case thermal resistance, and is more useful in setting the upper dissipation limit for cases where additional heat sinking is used.
- (3) Repetitive rating, pulsed, duty cycle ~1%, keep initial $T_J=25^\circ C$, the maximum allowed junction temperature of 175°C.
- (4) The static characteristics are obtained using ~380μs pulse, duty cycle ~1%.
- (5) The parameter is not subject to production test – verified by design / characterization.

TYPICAL CHARACTERISTICS

Ta=25°C, unless otherwise noted.

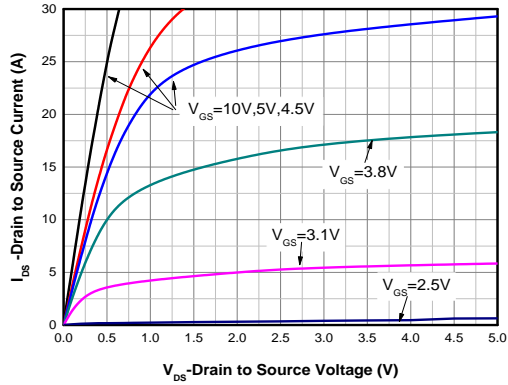

Output Characteristics (4)

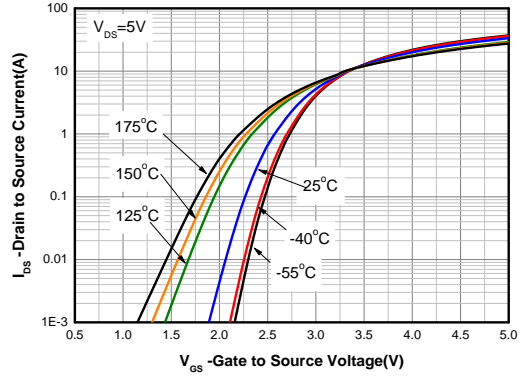

Transfer Characteristics (4)

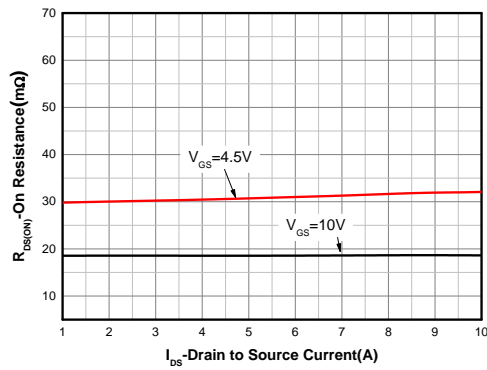

On-Resistance vs. Drain Current (4)

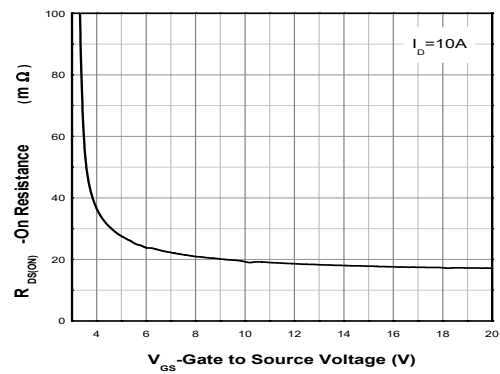

On-Resistance vs. Gate-to-Source Voltage (4)

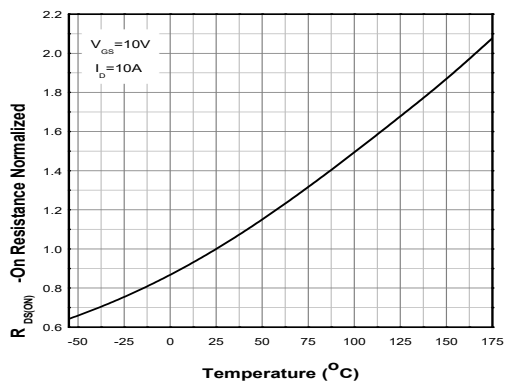

On-Resistance vs. Junction Temperature (4)

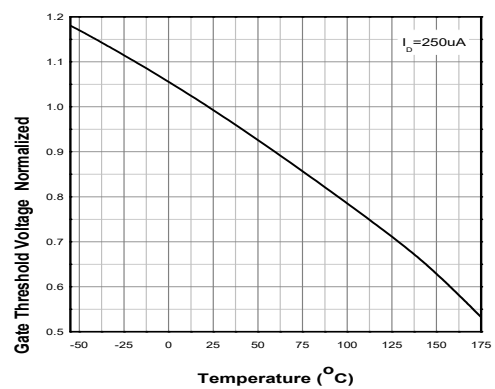

Threshold Voltage vs. Temperature

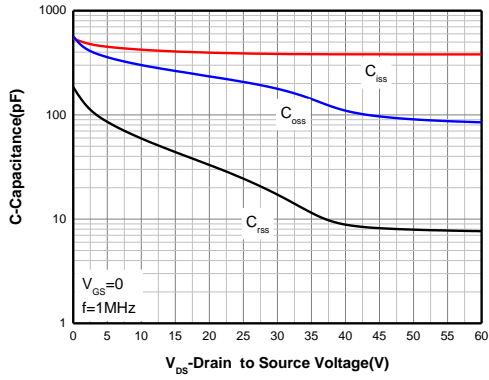
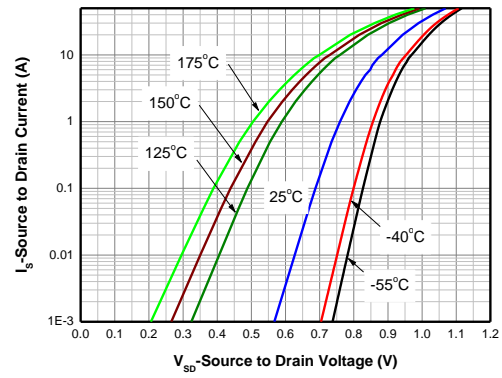
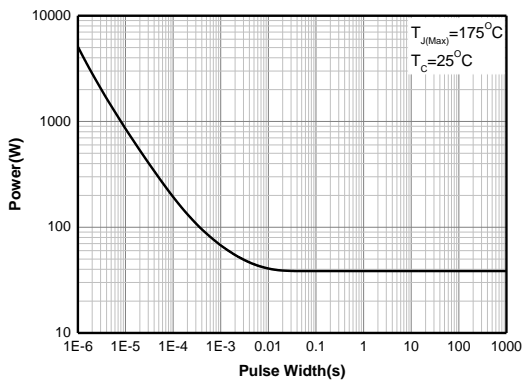
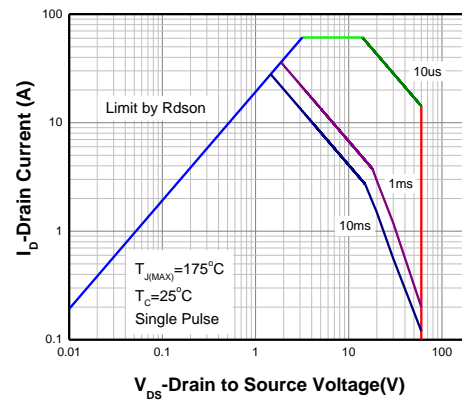
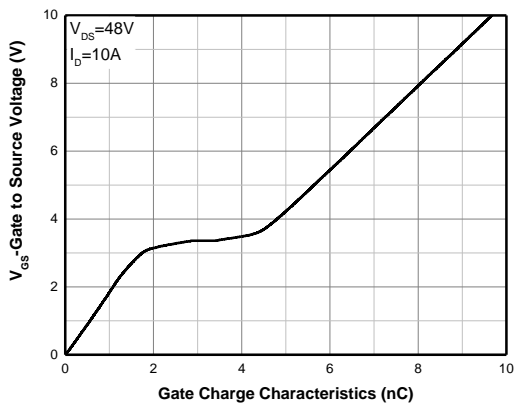
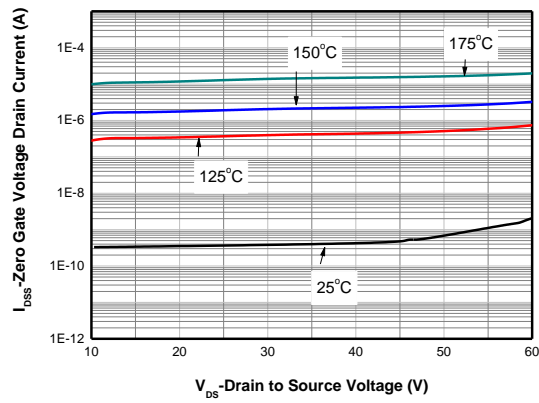
Capacitance

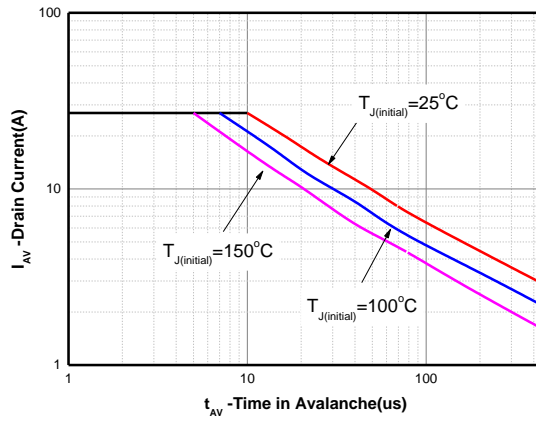
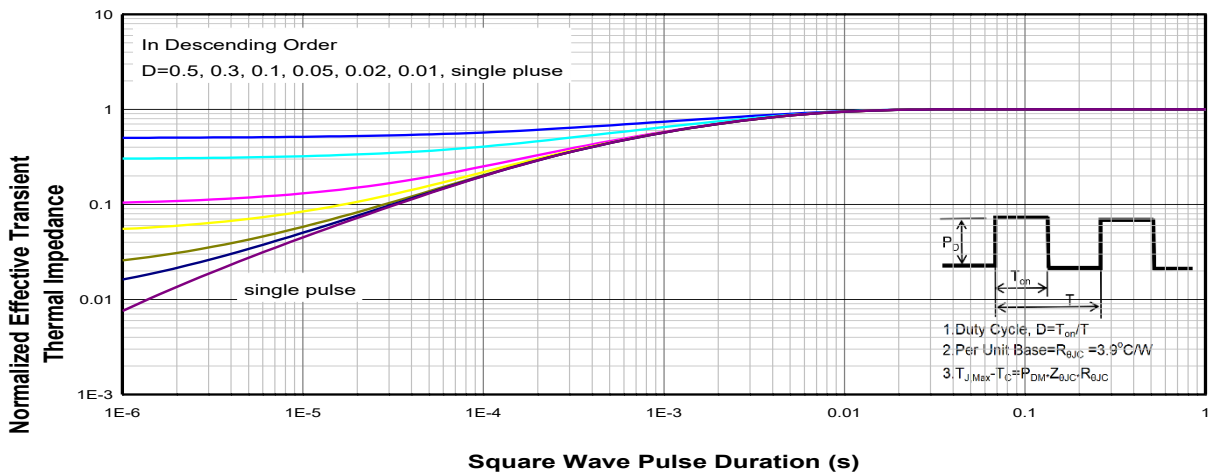
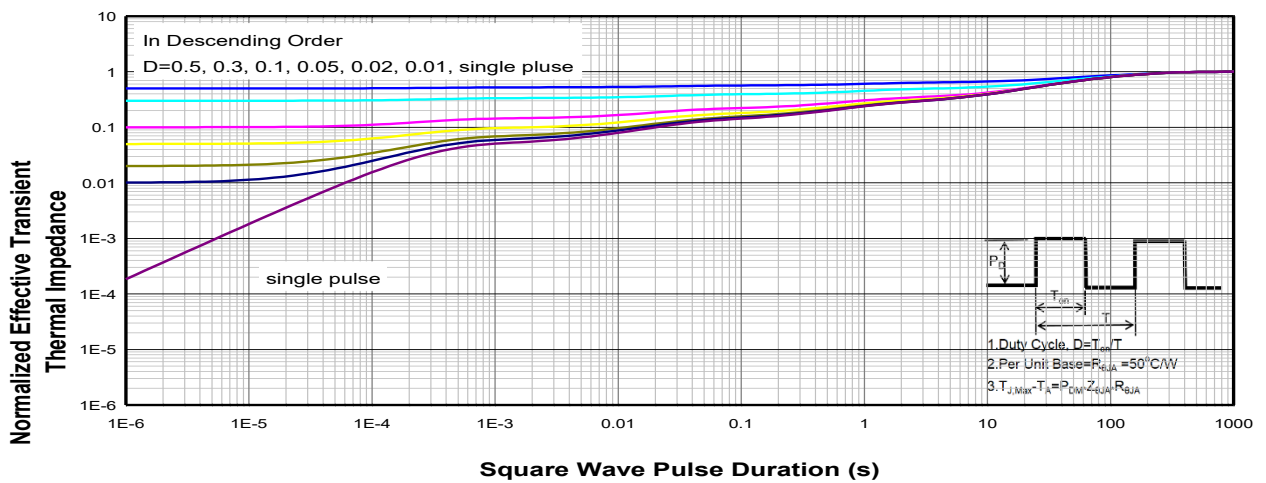
Body Diode Forward Voltage (4)

Single Pulse power

Safe Operating Area

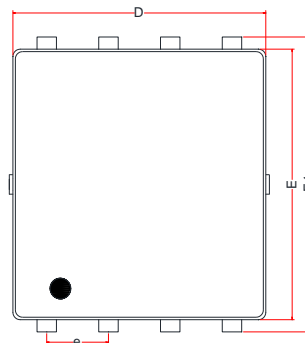
Gate Charge Characteristics

Drain Current vs. Drain Voltage



Avalanche characteristics

Transient Thermal Response (Junction-to-Case)

Transient Thermal Response (Junction-to-Ambient)

PDFN5*6-8L DIMENSIONS
PACKAGE SIZE

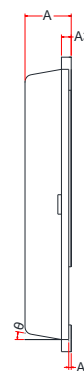
Symbol	Min.	Typ.	Max.
A	0.85	0.95	1.00
A1	0.00	---	0.05
A3	---	0.2 Ref	---
b	0.30	0.40	0.50
D	5.10	5.20	5.30
E	5.45	5.55	5.65
e	1.27 BSC		
D1	4.25	4.35	4.45
E1	5.95	6.05	6.15
E2	3.525	3.625	3.725
E3	1.175	1.275	1.375
L	0.45	0.55	0.65
L1	0	---	0.15
L2	0.68 Ref		
θ	0 °	---	10 °



TOP VIEW



SIDE VIEW

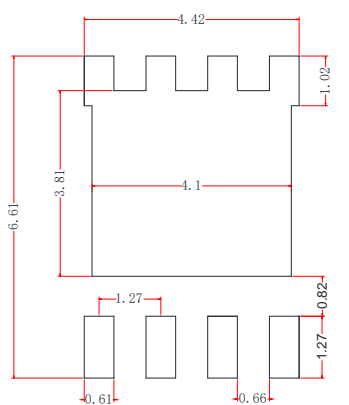

RECOMMENDED LAND PATTERN (Unit:mm)

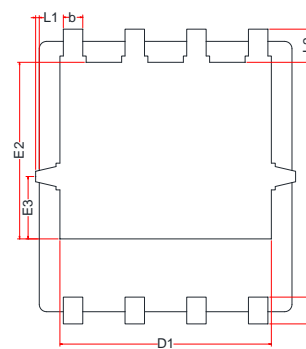

BOTTOM VIEW

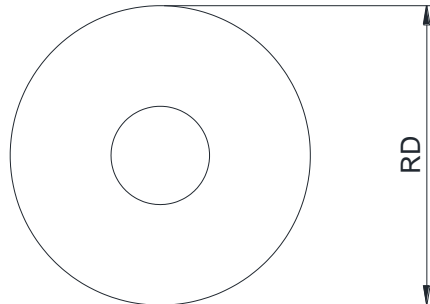
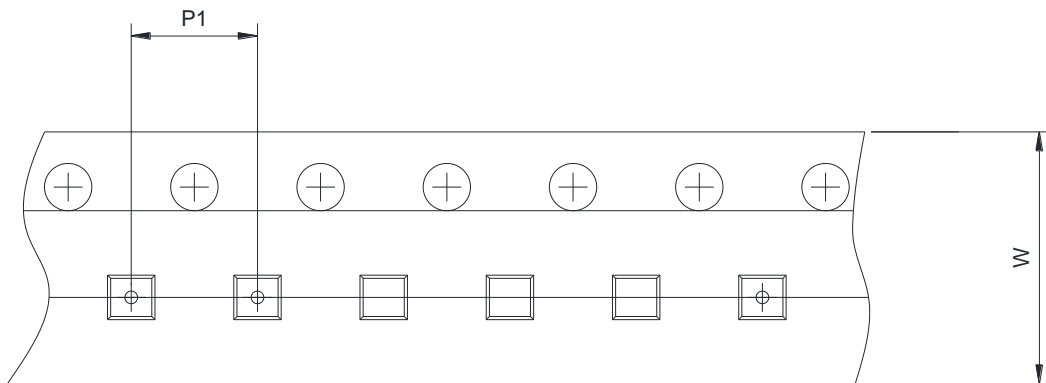
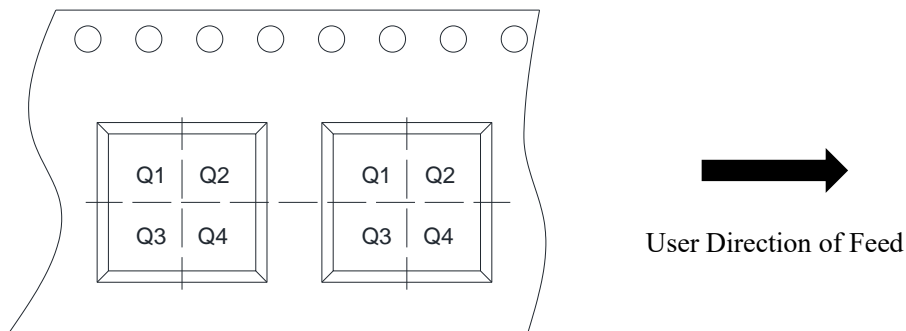
TAPE AND REEL INFORMATION
Reel Dimensions

Tape Dimensions

Quadrant Assignments For PIN1 Orientation In Tape

RD	Reel Dimension	<input type="checkbox"/> 7inch	<input checked="" type="checkbox"/> 13inch
W	Overall width of the carrier tape	<input type="checkbox"/> 8mm	<input checked="" type="checkbox"/> 12mm <input type="checkbox"/> 16mm
P1	Pitch between successive cavity centers	<input type="checkbox"/> 2mm	<input type="checkbox"/> 4mm <input checked="" type="checkbox"/> 8mm
Pin1	Pin1 Quadrant	<input checked="" type="checkbox"/> Q1	<input type="checkbox"/> Q2 <input type="checkbox"/> Q3 <input type="checkbox"/> Q4

ORDERING INFORMATION

TYPE NUMBER	PACKAGE	PACKING
SNM0625DNAQ-8/TR	PDFN5×6-8L	Tape and reel

PDFN5×6-8L is packed with 5000 pieces/disc in braided packaging.

Important statement

SIT reserves the right to change the above-mentioned information without prior notice.

REVISION HISTORY

Version number	Datasheet status	Revision date
V1.0	Initial version.	April 2024